

SPECIFICATION FOR APPROVAL

Model NO: B0105-01/8F

Item Code: 8 Inch LED Down Light

Model NO: V1.2

发行者: Berdis Lighting Co.,LTD.

版权者: Berdis Lighting Co.,LTD.

Customer Confirm :

TESTED BY	CHECKED BY	APPROVED BY

Berdis Confirm :

PREPARED BY	CHECKED BY	APPROVED BY
Tony Lai		

一、 Application:

- ★ Energy efficient: The Utilization more than 80% form electric energy into Light energy for LED, can save energy more 70% than traditional down lights;
- ★ Life time: The lifetime over 50000hs if calculated according to 50% light decay, especially suited to the lighting for a long time or the high altitude, etc;
- ★ Good light effect: Soft light, good CRI, start quickly, no flicker,;
- ★ High compatibility: LED 's installation size match traditional down light;
- ★ Input Voltage: NON-Dimmable,AC85-265V, DimmableAC200-240V, Power Factor \geq 0.9,;
- ★ Easy installation: the installation without changing the original circuit can be directly connected to AC power.
- ★ Environmental protection: LED Down light have no ultraviolet, infrared and other radiation, no mercury and other harmful substances, less heat;

Applications: LED down light have outstanding performance in Large-scale indoor lighting for that energy saving, environmental protection and lifetime, product is suitable for supermarkets, shopping malls, schools, hospitals, municipal buildings, showrooms, office, home and other indoor lighting.。

二、 SIZE:

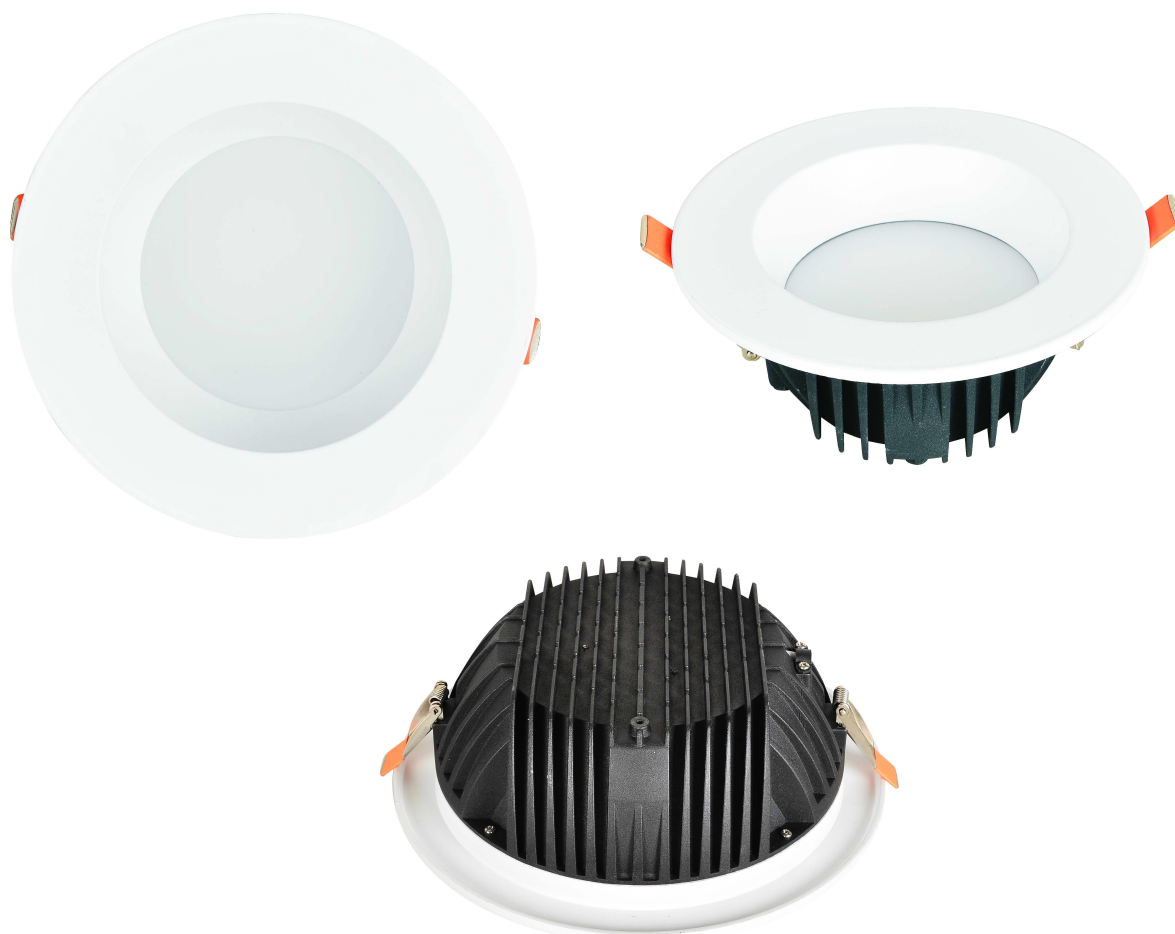

三、Optical Specifications:

Power	36W			
LED Package	SMD5730			
LED Number	72			PCS
Light angle	90			°
CRI \geq	82			Ra
Color temperature	2700-3300	4000-4500	5700-6300	K
Luminous Efficiency \geq	80	82	85	LM/W
Illuminance \geq	1m=576 ; 2m=144 ; 3m=64 ; 4m=36 ;			LUX

四、Electric specifications:

Input voltage	NON-Dimmable:AC85-265V	Dimmable:AC110-265V
Working frequency	50/60	
LED Working current	850 \pm 5%	
PF \geq	90	
Power supply efficiency \geq	86	
EMC	C-Tick/SAA/CE/ROHS/IEC/IC-F	*****
Safety standard	IEC 61347-2-13; AS/NZS 61347.1:2002	A1311734EA

五、Mechanism:

Material	Aluminum	
AC cable length	150	mm
DC cable length	300	mm
Hole size	Φ 210	mm
Lamp size	Φ 240*75	mm
Protection class	IP20	***

六、 Environment:

Operating temperature	-10~40	°C
Operating humidity	≤85	%RH
Store temperature	-30~65	°C
Store humidity	≤85	%RH

七、 Package:

Box size	L255*W255*H90	mm
Carton size	L765*W510*H360	mm
N.W/PCS	1.02	KG
G.W/PCS	1.15	KG
N.W/CTN	24.48	KG
G.W/CTN	27.48	KG

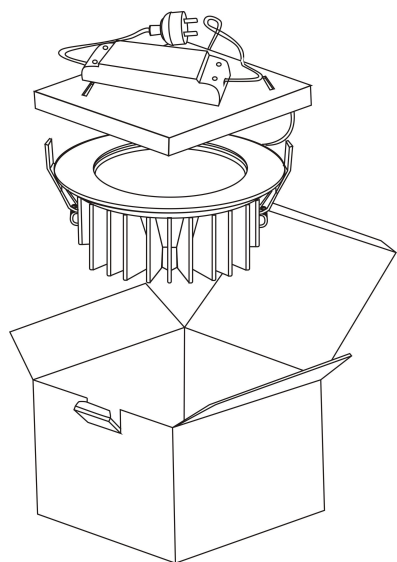

Package diagrammatic sketch

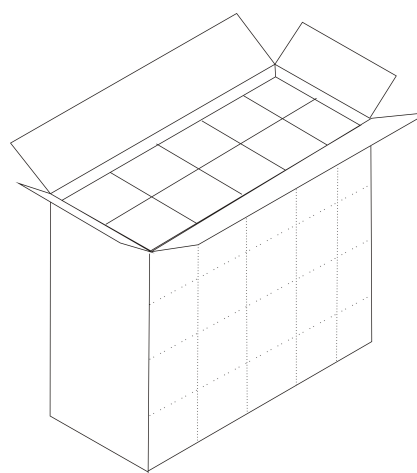

(24PCS)

Carton diagrammatic sketch

八、Diagrammatic sketch for installation:

1. Open a mounting hole A with diameter $\phi 210\text{mm}$ as shown in figure 1:

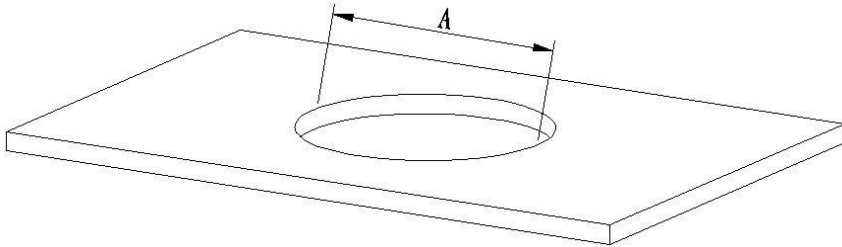

Figure 1

2. Pull out the power supply connect to the driver input, then fold up the mounting clip 90 degrees as shown in figure 2;

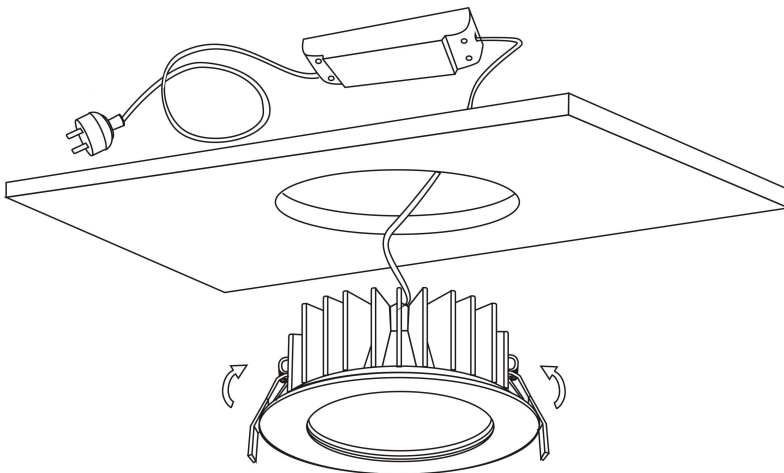

Figure 2

3. Align the mounting holes and push up of arrow direction until it is completely installed in the ceiling, turn on the power, lighting installation is complete as shown in. figure 3.;

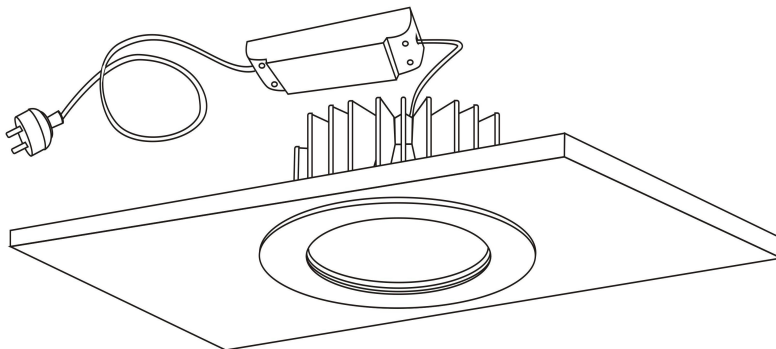

Figure 3

九、Manual:

. Please read the specification first to make sure the using condition is fit

- 1、 Please shut off the switch before connecting the product;
- 2、 Indoor use only;

十、 Test report

1. Warm white (3000±300K)
2. Daylight (6000±300K)