

**PRODUCTS  
 PROMOTION**



*SUPER-MINI Stainless-Steel spotlight Ip68*



## SUPER-MINI outdoor spotlight IP68

1-1 B1401-01/A  
 Cut-out:Ø9



1-2 B1401-01/B  
 Cut-out:Ø11



1-3 B1401-01/C  
 Cut-out:Ø12



2-1 B1401-02/A1  
 Cut-out:Ø16



2-2 B1401-02/A2  
 Cut-out:Ø16  
 Anti-glare standard



3-1 B1401-02/B1  
 Cut-out:Ø19



3-2 B1401-02/B2  
 Cut-out:Ø19  
 Anti-glare standard



4-1 B1401-02/C1  
 Cut-out:Ø23



4-2 B1401-02/C2  
 Cut-out:Ø23  
 Anti-glare standard



5 B1401-03/C Cut-out:Ø30  
 B1401-04/C Cut-out:Ø38



6 B1401-03/D Cut-out:Ø30  
 B1401-04/D Cut-out:Ø38  
 Honeycomb Mesh  
 Anti-glare standard



7 B1301-03/A Cut-out:Ø30  
 B1301-04/A Cut-out:Ø38



8 B1401-03/B Cut-out:Ø30  
 B1401-04/B Cut-out:Ø38  
 Honeycomb Mesh  
 Anti-glare standard



**Under-water light**  
**STAINLESS-STEEL MATERIAL**



1-1

Item NO.:B1401-01/A  
 Power:0.1W/0.2W  
 CRI.:90  
 Beam angle:60°  
 Material :304 / 316 stainless-steel  
 Voltage:12V/24V  
 IP Rating:68

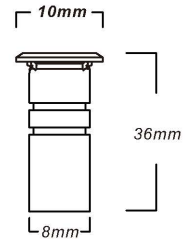

1-2

Item NO.:B1401-01/B  
 Power:0.2W/0.5W  
 CRI.:90  
 Beam angle:60°  
 Material :304 / 316 stainless-steel  
 Voltage:12V/24V  
 IP Rating:68

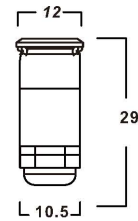

1-3

Item NO.:B1401-01/C  
 Power:0.2W/0.5W/1W  
 CRI.:90  
 Beam angle:60°  
 Material :304 / 316 stainless-steel  
 Voltage:12V/24V  
 IP Rating:68



- Color: Original Color,White, gray, black

LED : **OSRAM** **CREE**

STAINLESS-STEEL MATERIAL  
SUPER-MINI under-water spotlight



**2-1** Normal standard

B1401-02/A1  
Size: Ø22\*33

Foggy glass  
Clear Glass  
Normal standard

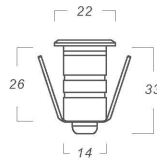

**2-2** Anti-glare standard

B1401-02/A2  
Size: Ø22\*42

Foggy glass  
Clear Glass  
Anti-glare standard

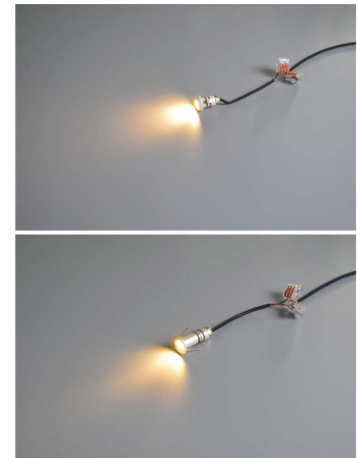
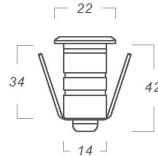

- IP Rating: 68
- Optics: Clear glass, Foggy glass
- Material : Stainless-Steel 304/316
- Color: Original Color, White, Gray, Black



Assemble box

LED : OSRAM CREE

Item NO.	Power	Cut-out	Size	CRI	Beam angle	Lumen	Voltage
B1401-02/A1	1W	Ø16	Φ 22*33mm	90	45°/60°/90°	70lm/w	12V/24V
B1401-02/A2	1W	Ø16	Φ 22*42mm	90	45°/60°	50lm/w	12V/24V

STAINLESS-STEEL MATERIAL  
SUPER-MINI under-water spotlight

IP68

3-1 Normal standard

B1401-02/B1  
Size: Ø25\*36

Foggy glass  
Clear Glass  
Normal standard

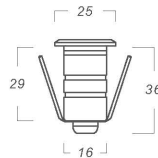

3-2 Anti-glare standard

B1401-02/B2  
Size: Ø25\*46

Foggy glass  
Clear Glass  
Anti-glare standard

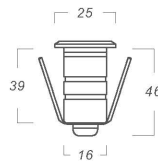

LED : OSRAM CREE



- IP Rating: 68
- Optics: Clear glass, Foggy glass
- Material : Stainless-Steel 304/316
- Color: Original Color, White, Gray, Black



Assemble box

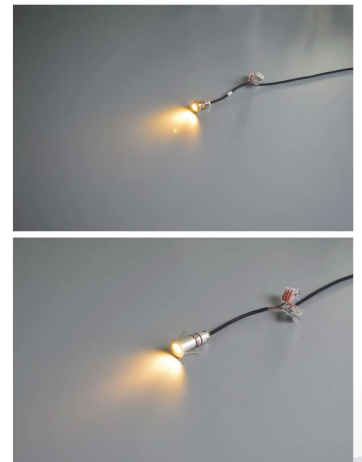

Item NO.	Power	Cut-out	Size	CRI	Beam angle	Lumen	Voltage
B1401-02/B1	1W/2W	Ø19	Φ25*36mm	90	45°/60°/90°	70lm/w	12V/24V
B1401-02/B2	1W/3W	Ø19	Φ25*46mm	90	45°/60°	50lm/w	12V/24V



**4-1** Normal standard

B1401-02/C1  
Size: Ø31\*35

Foggy glass  
Clear Glass  
Normal standard

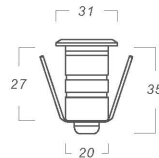

**4-2** Anti-glare standard

B1401-02/C2  
Size: Ø31\*35

Foggy glass  
Honeycomb Mesh  
Anti-glare standard

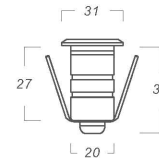

LED : OSRAM CREE



- IP Rating: 68
- Optics: Clear glass, Foggy glass
- Material : Stainless-Steel 304/316
- Color: Original Color, White, Gray, Black



Assemble box

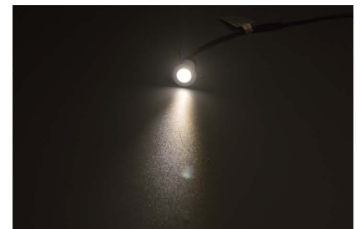

Item NO.	Power	Cut-out	Size	CRI	Beam angle	Lumen	Voltage
B1401-02/C1	1W/2W	Ø23	Φ 31*35mm	90	10°/25°/45°/60°/90°	80lm/w	12V/24V
B1401-02/C2	1W/2W	Ø23	Φ 31*35mm	90	10°/25°/45°/60°/90°	60lm/w	12V/24V

## Appearance Options

Freely match with different color/type frames

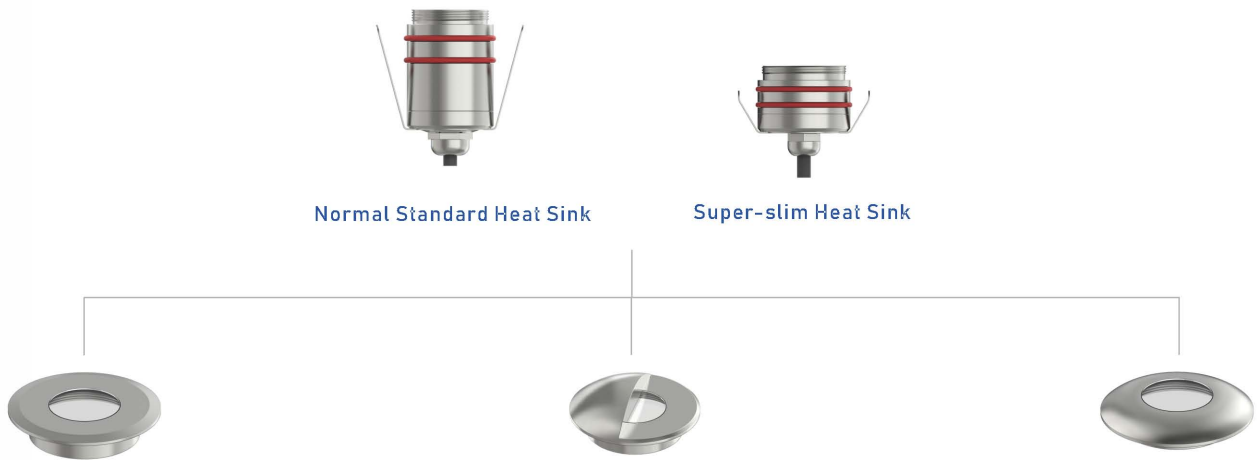

## Two delivery standard

- Heat sink and frame deliver dividually, free to DIY , IP Rating: **67**.
- Heat sink and frame assembled together , not possible to diassemble , IP Rating: **68**.
- Color: Original Color, White, Gray, Black

5-1

B1401-03/C1 Ø30  
B1401-04/C1 Ø38  
Foggy glass  
Normal standard

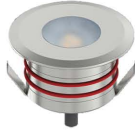

5-2

B1401-03/C2 Ø30  
B1401-04/C2 Ø38  
Foggy glass  
Normal standard



5-3

B1401-03/C3 Ø30  
B1401-04/C3 Ø38  
Foggy glass  
Normal standard

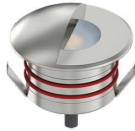

- DIY
- Save stock
- Match flexibly
- Frame can be replaced by yourself



Assemble box

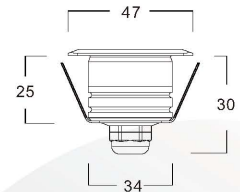
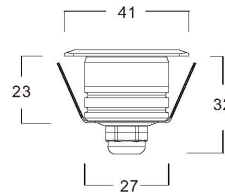

LED : OSRAM CREE

Item NO.	Power	Cut-out	Size	CRI	Beam angle	Lumen	Voltage
B1401-03/C	1W/3W	Ø30	Φ 41*30mm	90	90°	80lm/w	12V/24V
B1401-04/C	1W/3W	Ø38	Φ 47*32mm	90		80lm/w	12V/24V



# Honeycomb Mesh

## Anti-glare standard



6-1

B1401-03/D1 Ø30  
B1401-04/D1 Ø38  
Foggy glass  
Honeycomb Mesh  
Anti-glare standard



6-2

B1301-03/D2 Ø30  
B1401-04/D2 Ø38  
Foggy glass  
Honeycomb Mesh  
Anti-glare standard



6-3

B1401-03/D3 Ø30  
B1401-04/D3 Ø38  
Foggy glass  
Honeycomb Mesh  
Anti-glare standard



- DIY
- Save stock
- Match flexibly
- Frame can be replaced by yourself



Assemble box

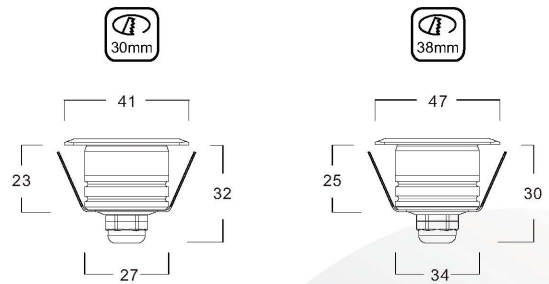

LED : OSRAM CREE

Item NO.	Power	Cut-out	Size	CRI	Beam angle	Lumen	Voltage
B1401-03/D	1W/3W	Ø30	Φ 41*30mm	90	90°	60lm/w	12V/24V
B1401-04/D	1W/3W	Ø38	Φ 47*32mm	90		60lm/w	12V/24V

7-1

B1401-03/A1 Ø30  
B1401-04/A1 Ø38  
Clear Glass  
Normal standard



7-2

B1401-03/A2 Ø30  
B1401-04/A2 Ø38  
Clear Glass  
Normal standard



7-3

B1401-03/A3 Ø30  
B1401-04/A3 Ø38  
Clear Glass  
Normal standard



- DIY
- Save stock
- Match flexibly
- Frame can be replaced by yourself

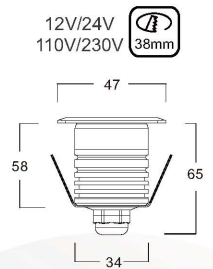
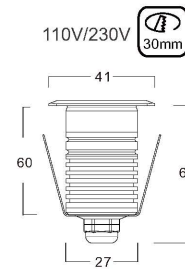
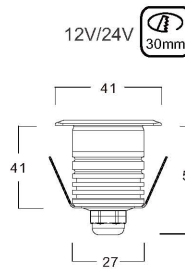

LED : OSRAM CREE

Item NO.	Power	Cut-out	Size	CRI	Beam angle	Lumen	Voltage
B1301-04/A1	1W/3W	Ø30	Φ 41*50mm	90	24°/30°/40°/60°	70lm/w	12V/24V 110V/230V
B1301-04/A2	1W/3W	Ø30	Φ 41*69mm	90	25°*45° 30°*60°	70lm/w	12V/24V 110V/230V
B1301-05/A1	1W/3W	Ø38	Φ 41*55mm	90	15°*30° 15°*45° 15°*60° 15°/24°/30°/40°/60°/90°	70lm/w	12V/24V 110V/230V

# Honeycomb Mesh

## Anti-glare standard



**8-1**  
B1401-03/B1 Ø30  
B1401-04/B1 Ø38  
Clear Glass  
Honeycomb Mesh  
Anti-glare standard



**8-2**  
B1401-03/B2 Ø30  
B1401-04/B2 Ø38  
Clear Glass  
Honeycomb Mesh  
Anti-glare standard



**8-3**  
B1401-03/B3 Ø30  
B1401-04/B3 Ø38  
Clear Glass  
Honeycomb Mesh  
Anti-glare standard



- DIY
- Save stock
- Match flexibly
- Frame can be replaced by yourself

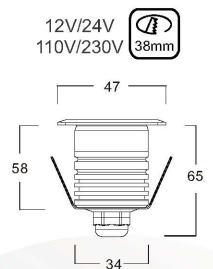
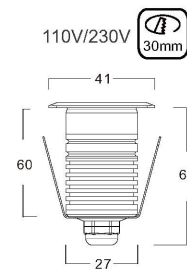
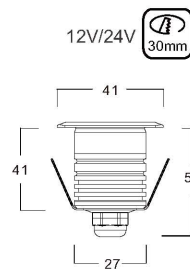

**LED : OSRAM CREE**

Item NO.	Power	Cut-out	Size	CRI	Beam angle	Lumen	Voltage
B1301-04/B 12V/24V	1W/3W	Ø30	Φ41*50mm	90	24°/30°/40°/60°	70lm/w	12V/24V
B1301-04/B 110V/230V	1W/3W	Ø30	Φ41*69mm	90	25°*45° 30°*60°	70lm/w	110V/230V
B1301-05/B	1W/3W	Ø38	Φ47*55mm	90	15°*30° 15°*45° 15°*60° 15°/24°/30°/40°/60°/90°	70lm/w	12V/24V 110V/230V

# Parallel connection solution

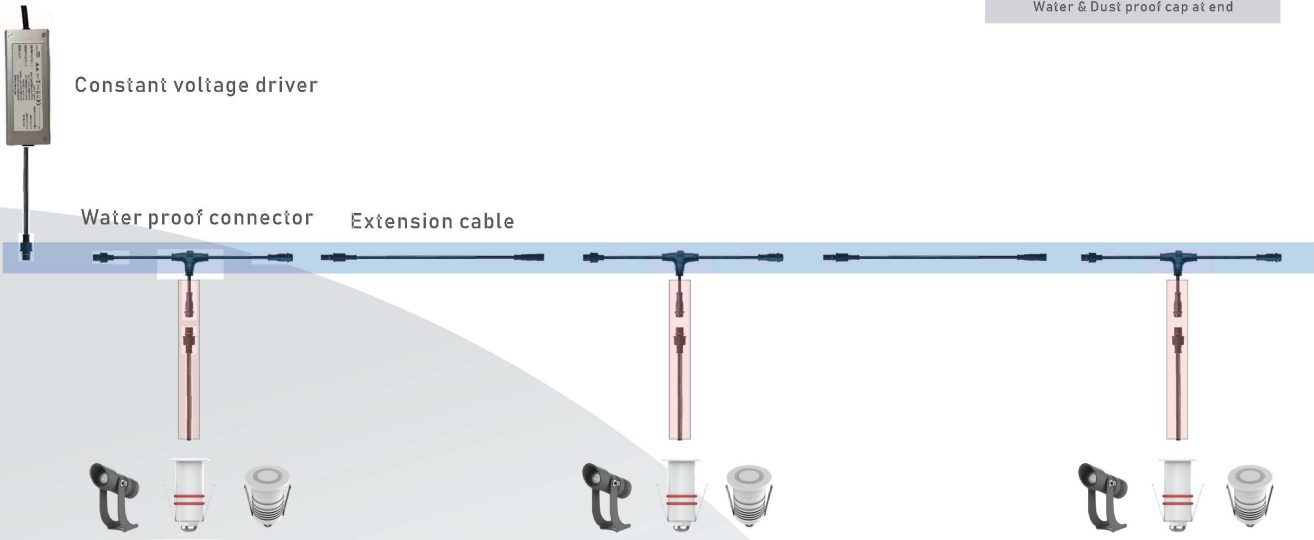
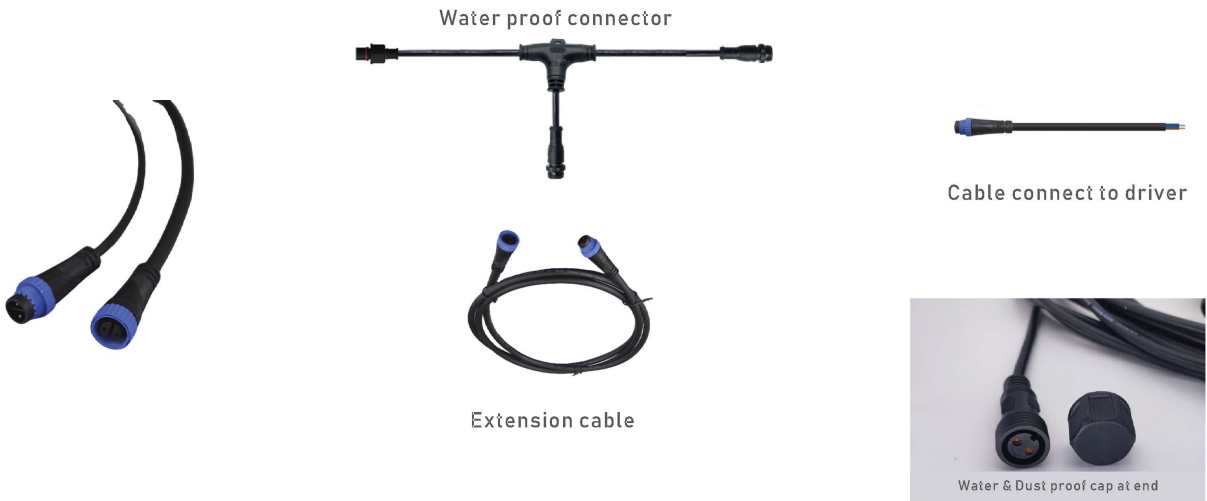

Main-Cable	Standard configuration	1 Meter and 3 Meter
	Max-2.5m <sup>2</sup>	10 Meter Main Cable, Maximum Load Wattage 80W
	Max-1.5m <sup>2</sup>	10 Meter Main Cable, Maximum Load Wattage 50W
Sub-Cable	Standard configuration	1 Meter Max-0.5m <sup>2</sup>



Assemble box

## Contact

**BERDIS LIGHTING (JIANG MEN) CO., LTD.**

RoRo Email: [sales2@berdisled.com](mailto:sales2@berdisled.com)

Add: NO.19-3, Chaoxing Road Xinhui District JiangMen City, Guangdong Province, China

[www.berdisled.com](http://www.berdisled.com)